

Mesa Logan

Logan Desk

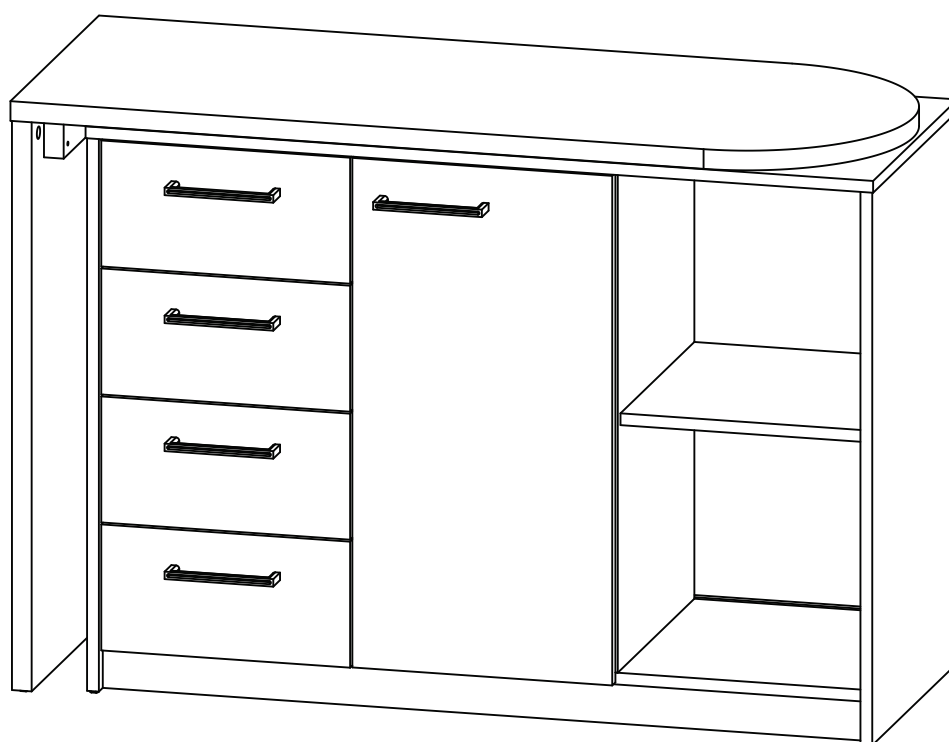

ARTANY[®]
Arte em Escritórios

Conheça outros produtos da nossa empresa no site: www.artany.com.br
Conozca otros productos en el sitio: www.artany.com.br
Know another products in: www.artany.com.br

- Siga atentamente todas as instruções de montagem;
- Monte seu produto no local ou próximo de onde será colocado. Movimentações do produto já montada, podem avariá-lo;
- Faça a montagem em uma superfície limpa e plana. Aconselhamos usar a própria embalagem de papelão para forrar o chão;
- Verifique se as quantidades de peças e acessórios estão de acordo com o manual de montagem;
- Compare atentamente os furos de cada peça com a ilustração do manual;
- Utilize as ferramentas indicadas. Só utilize parafusadeira se tiver conhecimento e habilidade. O uso inapropriado pode danificar peças e/ou acessórios;
- Se o produto necessitar fixação na parede, tenha cuidado para não atingir fios e canos ao furar a parede.

Obs: Caso necessite solicitar peças de reposição, por favor, utilize os códigos dos mesmos.

- Siga con atención todas las instrucciones de armado.
- Arme su mueble en un lugar cerca donde será instalado. Mover el producto ya montado puede perjudicarlo.
- Haga el montaje en una superficie limpia y plana. Aconsejamos usar el propio embalaje de cartón para forrar el suelo.
- Asegúrese de que las cantidades de piezas y accesorios coincidan con el manual de montaje.
- Compare cuidadosamente los agujeros de cada pieza con la ilustración del manual.
- Utilice las herramientas indicadas. Sólo utilice atornillador automático si tiene conocimiento y habilidad. El uso inapropiado puede dañar piezas y/o accesorios.
- Si el producto necesita fijación en la pared, tenga cuidado de no alcanzar cables y cañones al perforar la pared.

OBS: Si necesita solicitar piezas y / o accesorios de repuesto, por favor, utilice los códigos de los mismos.

- Follow carefully the assembly instructions.
- Assemble your furniture in a place near where it will be installed. Moving the assembled product can harm it.
- Make the assembly on a clean and flat surface. We recommend using the cardboard box to cover the floor.
- Make sure the quantities of parts and accessories match the assembly manual.
- Carefully compare the holes in each piece with the illustration in the manual.
- Use the indicated tools. Only use an automatic screwdriver if you have knowledge and skill. Improper use can damage parts and/or accessories.
- If the product needs fixing on the wall, be careful and don't reach cables and cannons when drilling the wall.

NOTE: If you need to request spare parts and/or accessories, please use the codes according of this instruction manual.

CONSERVAÇÃO E LIMPEZA

MANTENIMIENTO Y LIMPIEZA / MAINTENANCE AND CLEANING

Não expor o produto ao sol, altas temperaturas e umidade, mantendo-o em local seco e arejado. Para a limpeza, utilizar um pano seco e macio. Não é necessário o uso de materiais abrasivos ou álcool.

No exponga el producto al sol, altas temperaturas y la humedad. Mantener en local seco y ventilado. Para limpiar, utilice un paño suave y seco. No es necesario el uso de materiales abrasivos o alcohol.

Do not expose the product to sunlight, high temperatures and humidity. Keep it in a dry and ventilated place. To clean it, use a soft and dry cloth. It is not necessary to use abrasive materials or alcohol.

Garantia

Este certificado de Garantia é uma vantagem adicional oferecida ao consumidor, porém para que o mesmo tenha validade é imprescindível que seja apresentada a NOTA FISCAL de compra do produto e o número do lote (ver etiqueta).

Com este produto, a **Artany** tem como objetivo atender plenamente o proprietário-consumidor, proporcionando a garantia na forma aqui estabelecida, pelo período de 03 meses a partir da data da nota fiscal de compra. A **Artany** restringe a sua responsabilidade à substituição gratuita das peças defeituosas, em caso de defeitos ou avarias devidamente constatados como sendo de fabricação, durante a vigência desta garantia.

A **Artany** declara a garantia nula e sem efeito se o produto for alterado, adulterado, molhado ou consertado e ainda pela prática de montagem inadequada. Também será considerada nula em casos de força maior, como aqueles causados por agentes da Natureza (chuvas, incêndios, excesso de umidade...).

Para exercer seus direitos de comprador é importante que antes de montar seu produto você leia com atenção as instruções de cada passo do manual de montagem que acompanha o móvel.

Caso o produto não esteja em conformidade, entre em contato com a loja onde efetuou a compra ou com o nosso Serviço de Atendimento ao Cliente através do fone (41) 3556 1500 ou do e-mail assistencia@artany.com.br, e faça sua reclamação, apontando os defeitos técnicos observados, que teremos o maior prazer em atendê-lo. Para agilizar o seu atendimento, tenha sempre em mãos o manual de montagem com os respectivos números das peças defeituosas conforme descritas no manual.

FERRAMENTAS **NÃO** FORNECIDAS, MAS NECESSÁRIAS
PARA A MONTAGEM DO PRODUTO

HERRAMIENTAS **NO** SUMINISTRADAS, MAS NECESARIAS PARA EL MONTAJE DEL PRODUCTO
TOOLS **NOT** SUPPLIED, BUT NECESSARY FOR THE ASSEMBLY



100097

18X



100070

36X



100616

4X



100069

40X



102958

40X

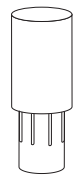

102433

4X

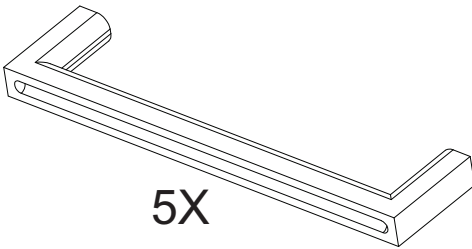

5X

102418

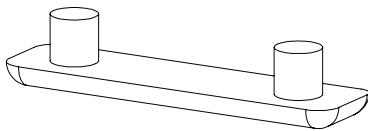

6X

102971



100201

44X



100594

8X



100503

10X



102807

16X



100584

6X

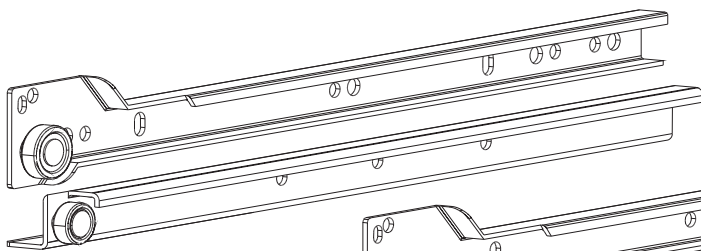

4X

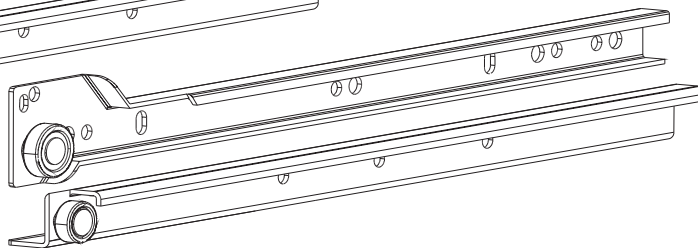

102317

DOBRADIÇA - 104173

BISAGRA / HINGES

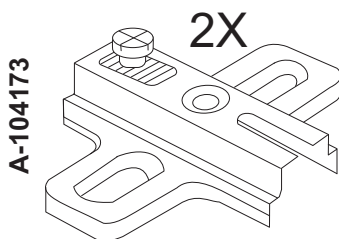

A-104173

2X

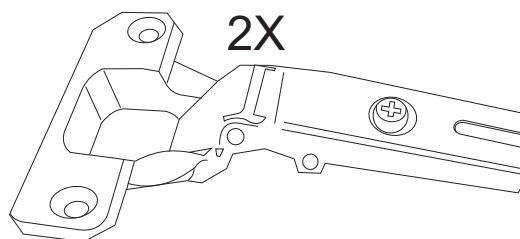

B-104173

2X

KIT ROLLY - 103015

KIT ROLLY / ROLLY KIT

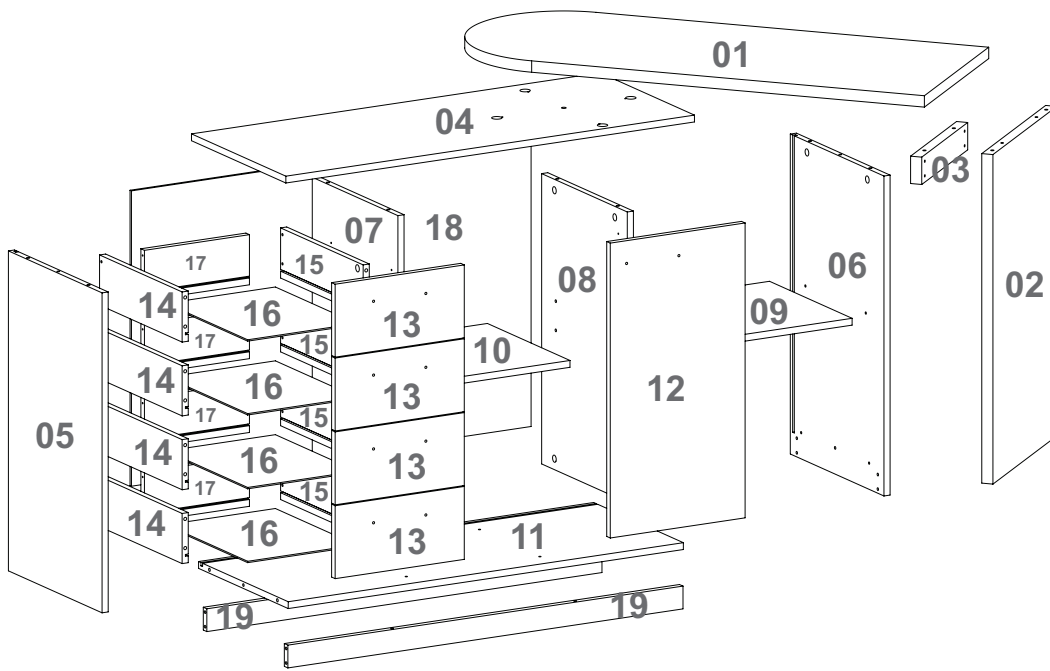
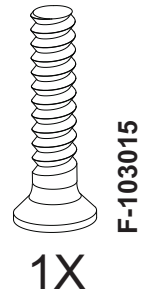
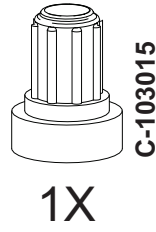
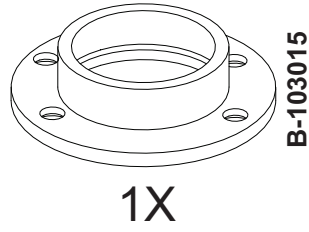
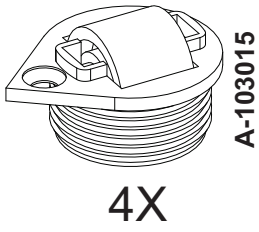

Número Número Number	Medida Dimensión Size	Cantidad Cantidad Quantity
01	1090x420x25mm	01
02	723x417x25mm	01
03	300x60x25mm	01
04	1000x400x15mm	01
05	702x397x15mm	01
06	702x397x15mm	01
07	637x363x15mm	01
08	637x363x15mm	01
09	350x312x15mm	01
10	350x312x15mm	01
11	967x380x15mm	01
12	647x330x15mm	01
13	316x160x15mm	04
14	350x110x15mm	04
15	350x110x15mm	04
16	345x267x3mm	04
17	257x110x15mm	04
18	978x648x6mm	01
19	967x50x15mm	02

1

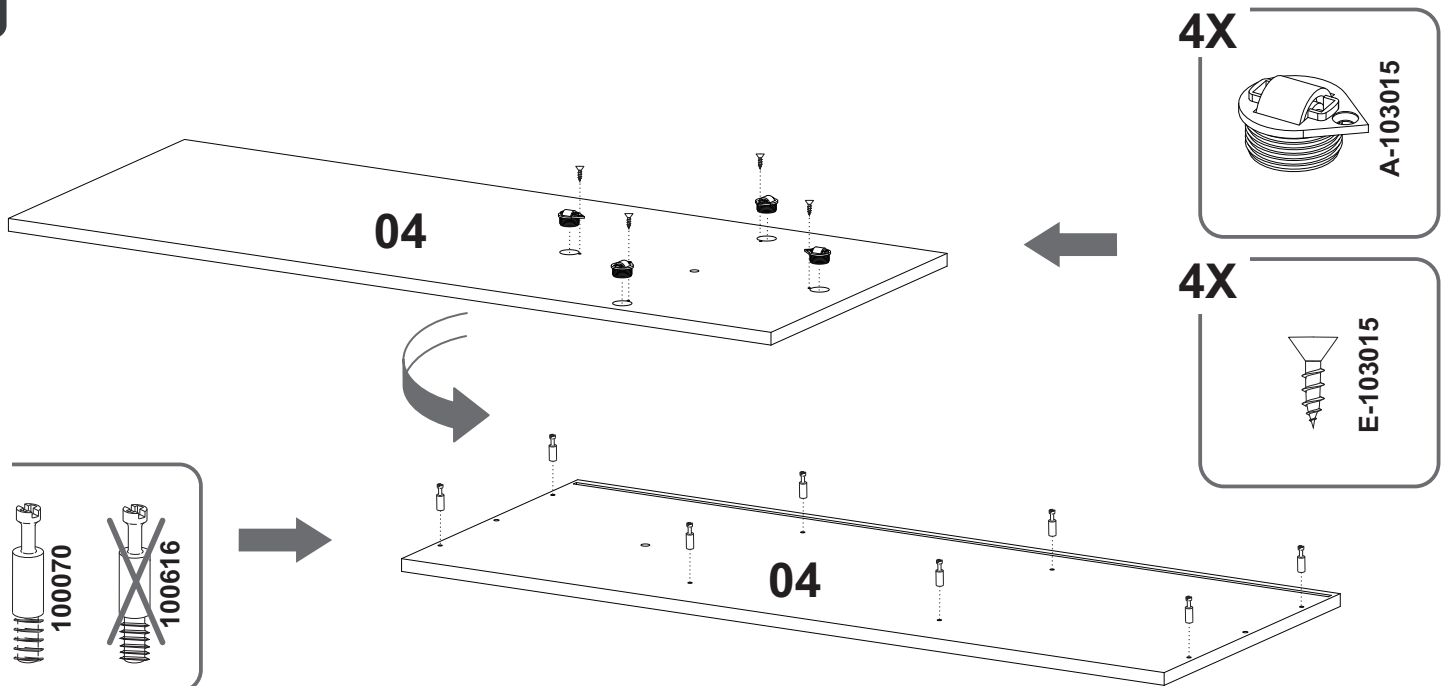

2

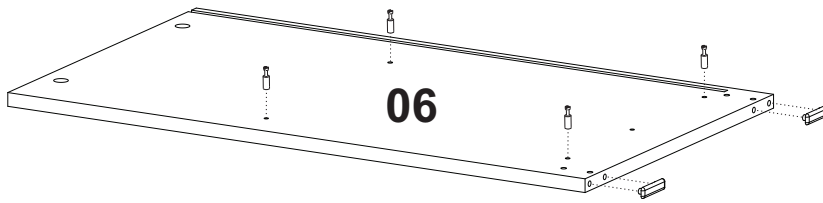

4X

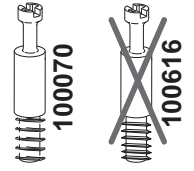

1X

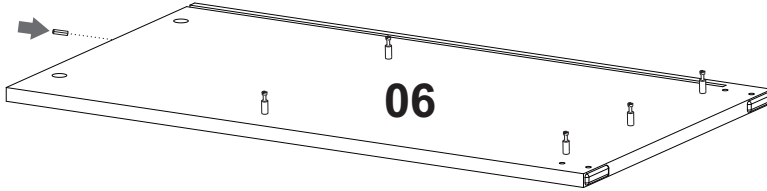
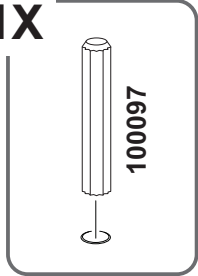

2X

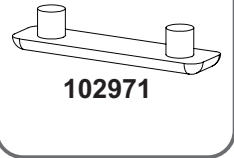

3

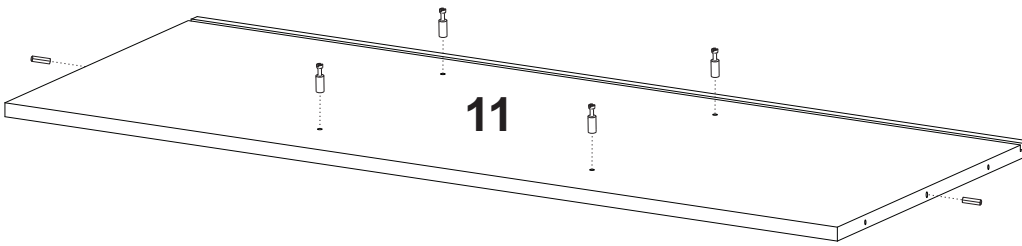

4X

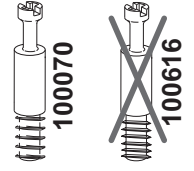

2X

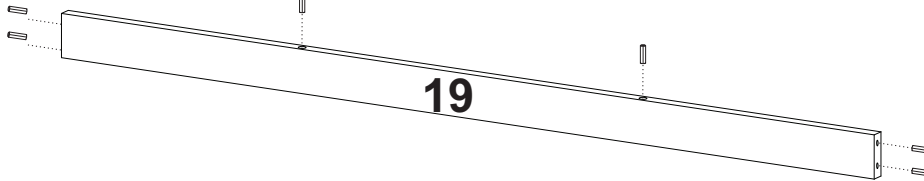

14X

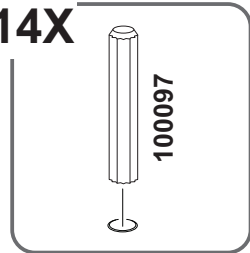

4

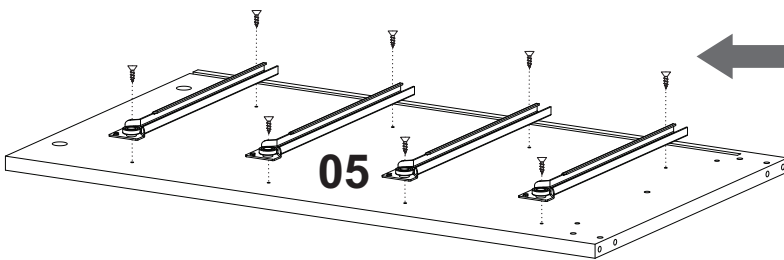

4X

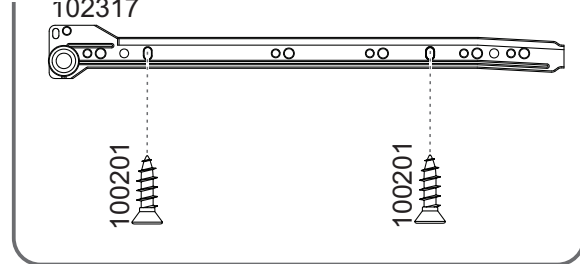

2X

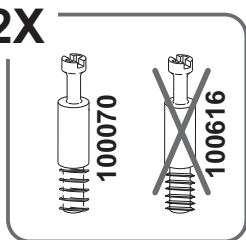

1X

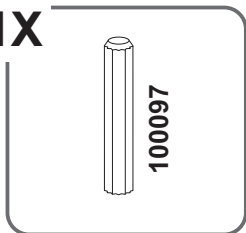

8X

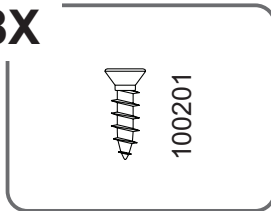

2X

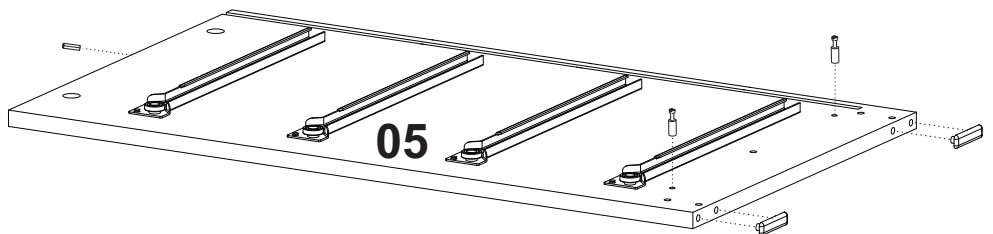
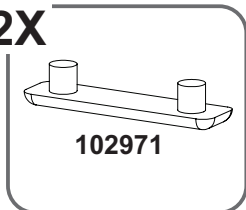

5

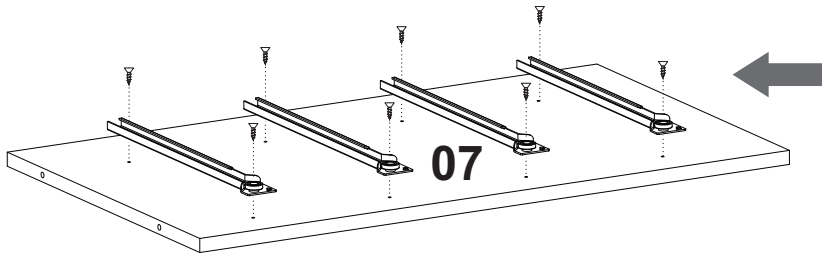

4X

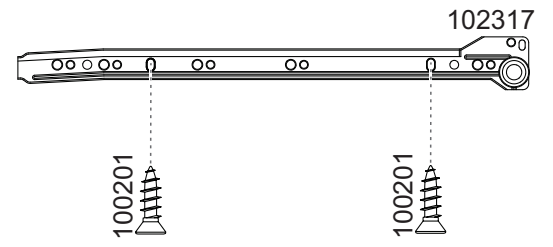

2X

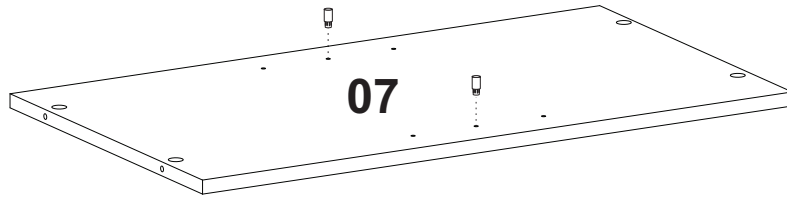
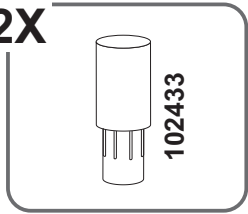

8X

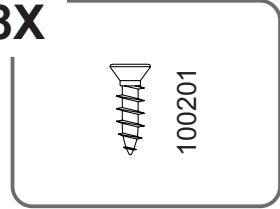

6

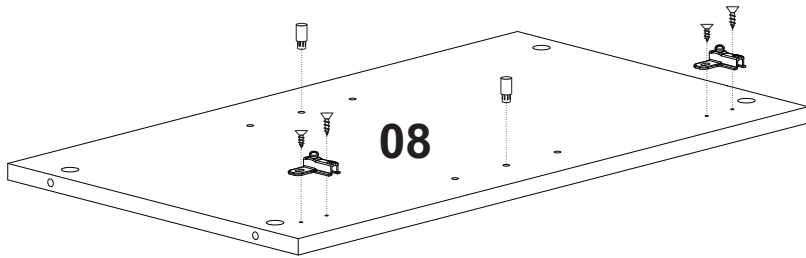

2X

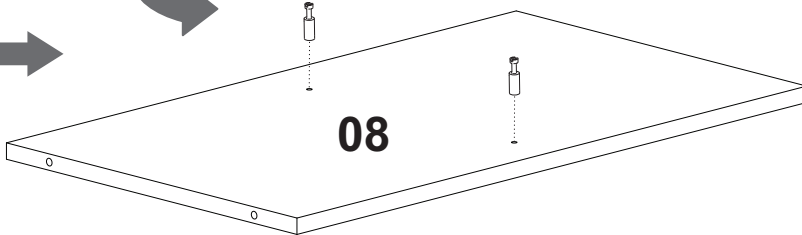
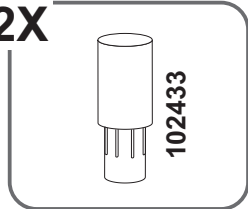

2X

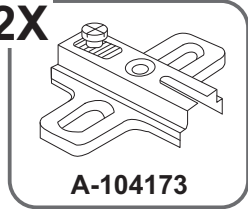

2X

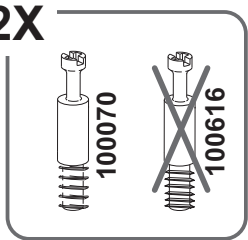

4X

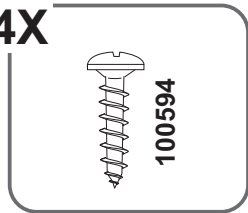

7

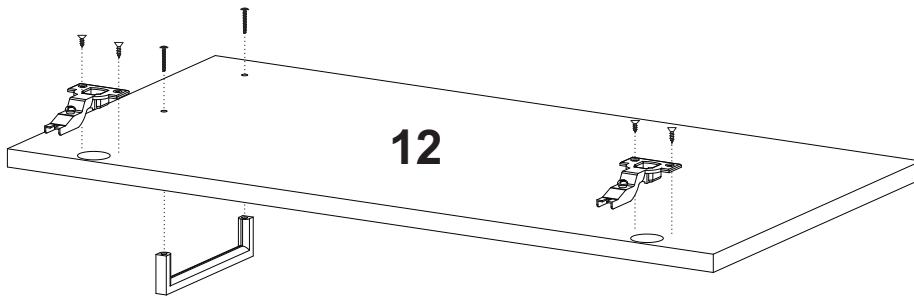

2X

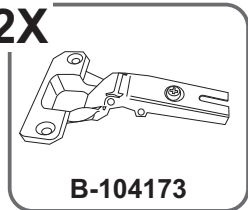

1X

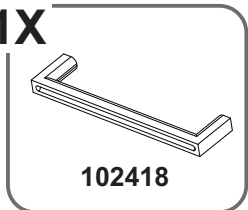

2X

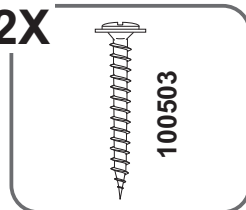

4X

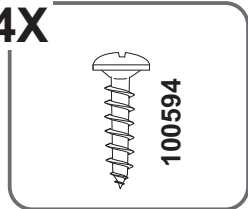

102418

100503

B-104173

100594

102317

100201

100201

102433

07

08

102433

A-104173

100070

100616

08

100594

12

100594

8

16X

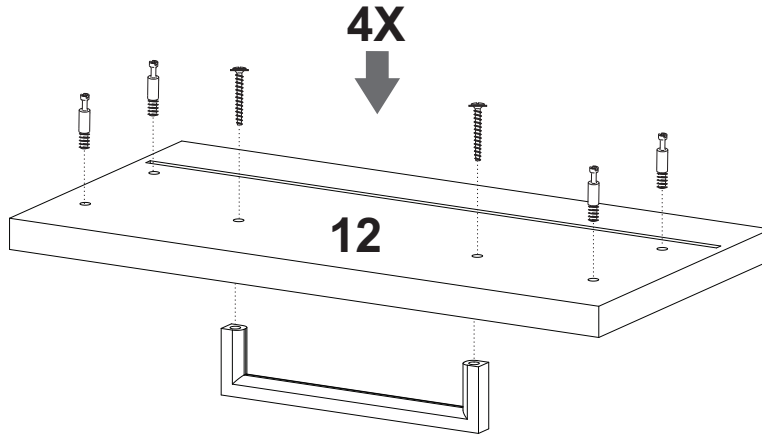
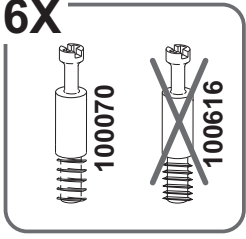

4X

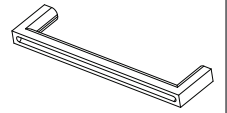

102418

8X



100503

9

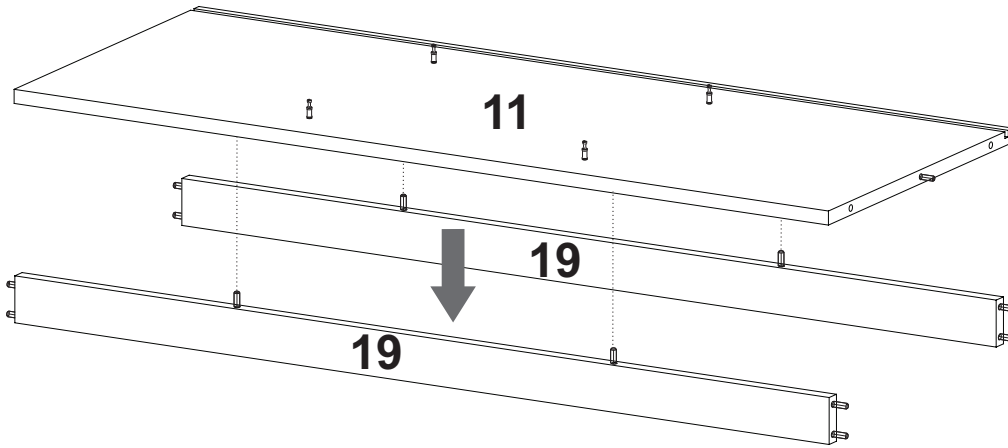

10

4X

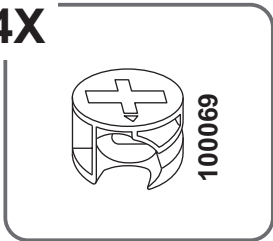

100069

4X

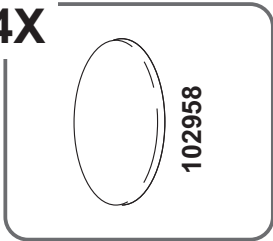

102958

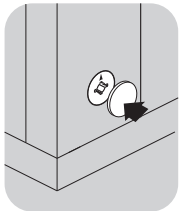
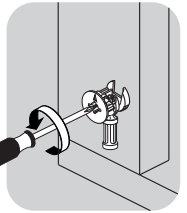
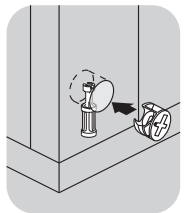
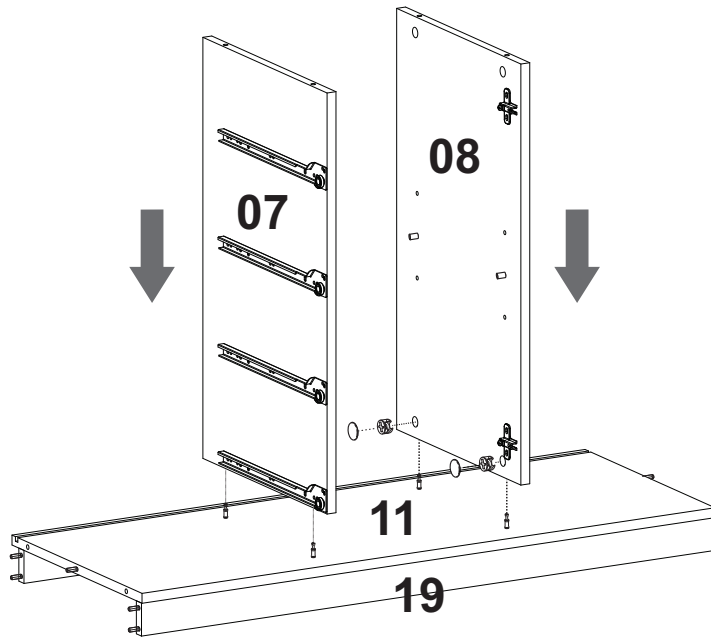

11

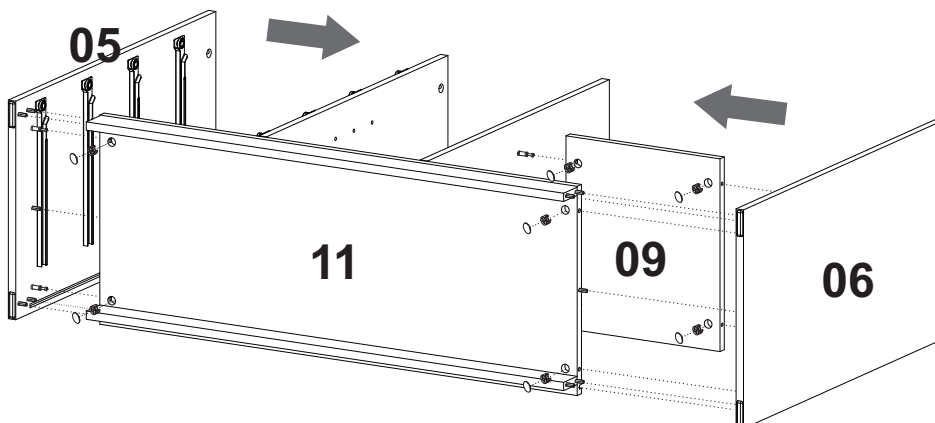

8X

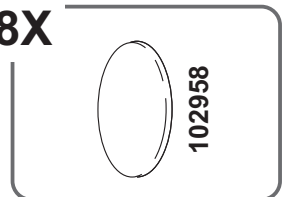

102958

8X

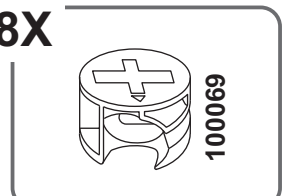

100069

12

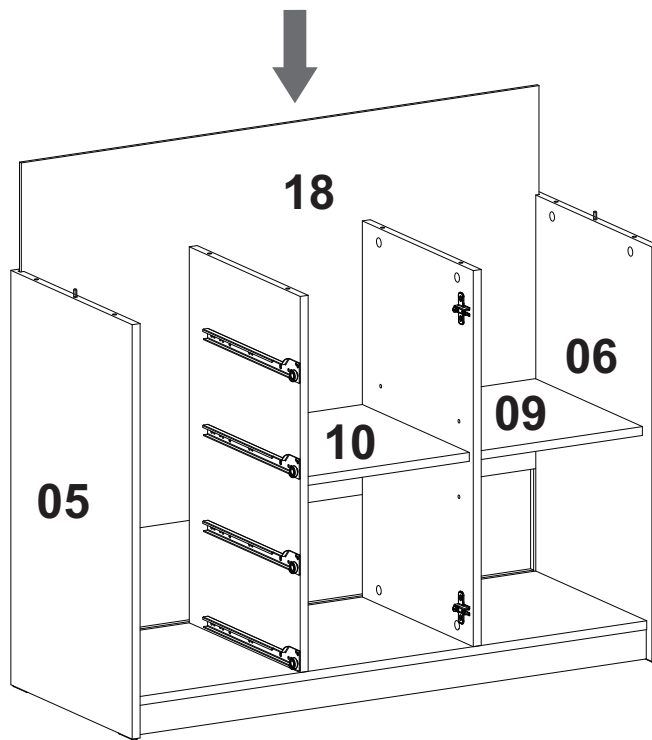

13

8X

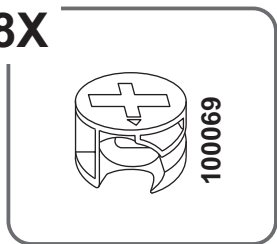

8X

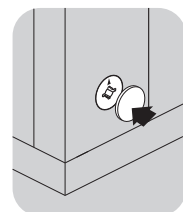
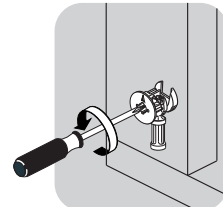
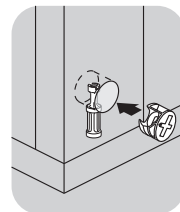
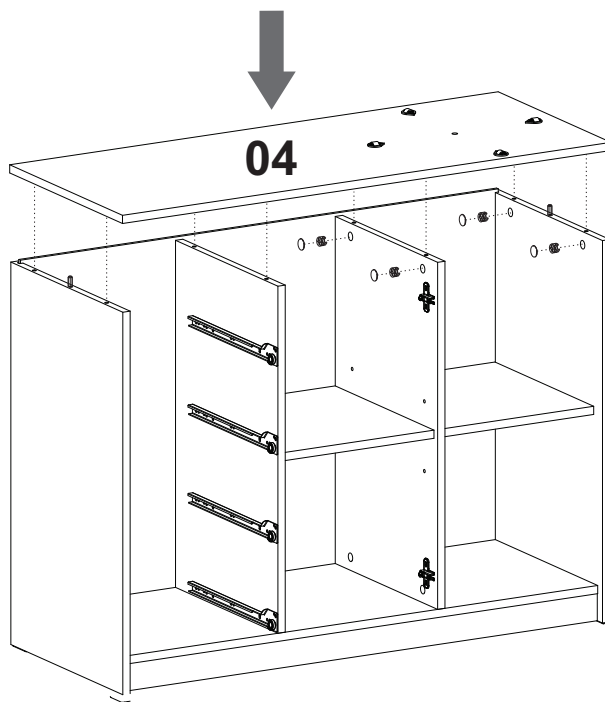
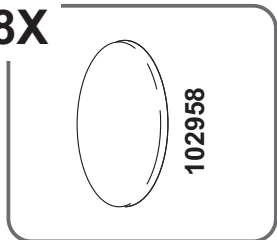

14

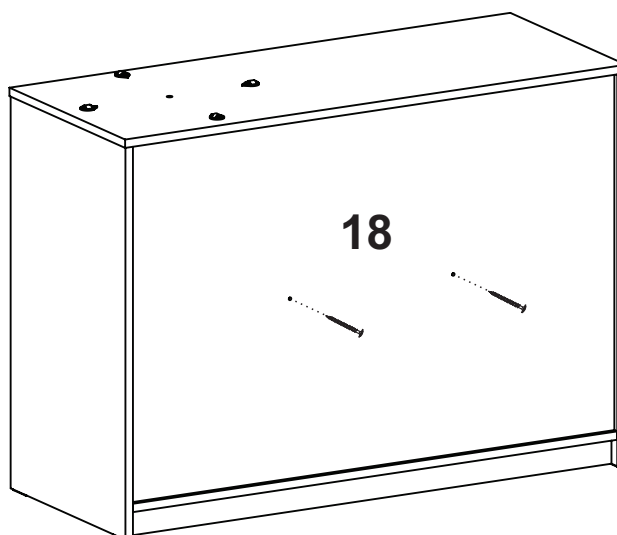

2X

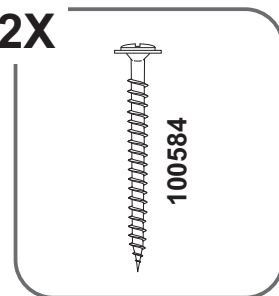

15

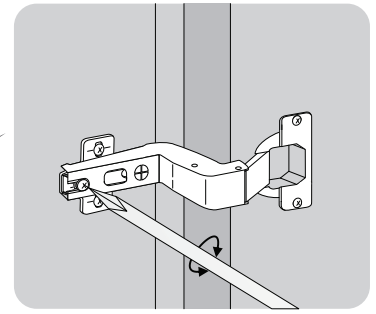
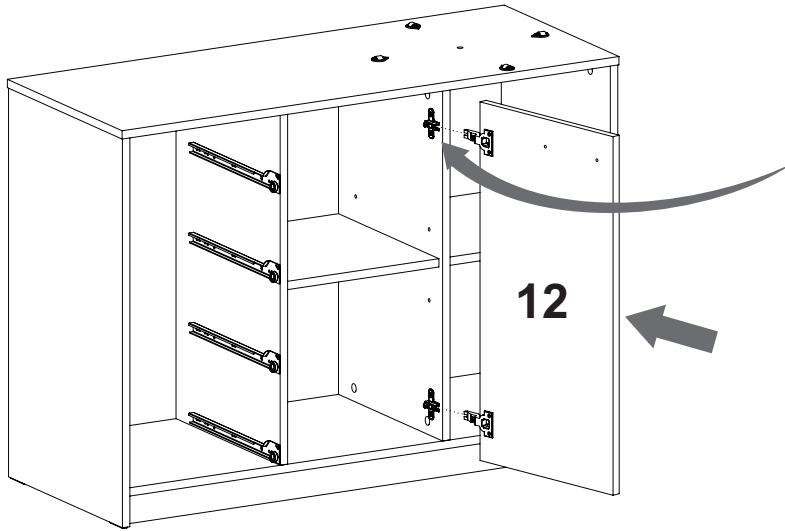

COMO AJUSTAR AS PORTAS

COMO AJUSTAR LAS PUERTAS / HOW TO ADJUST THE DOORS

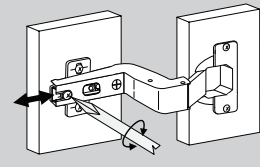
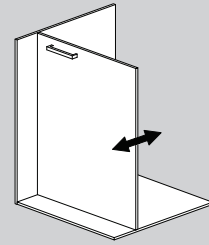
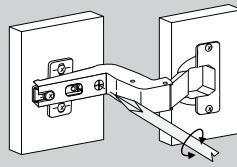
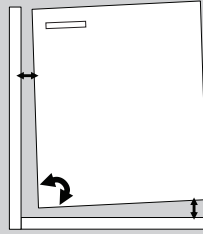
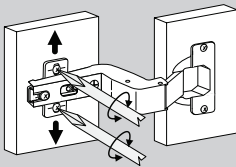
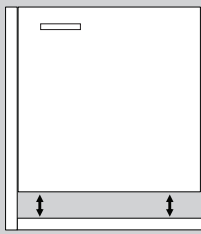

16

16X



100069

4X →

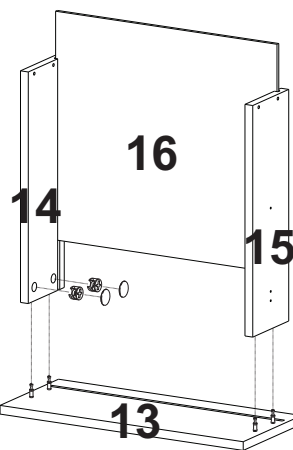

16X

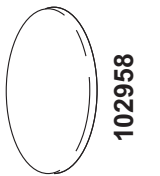

102958

16X



102807

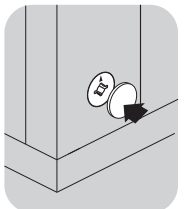
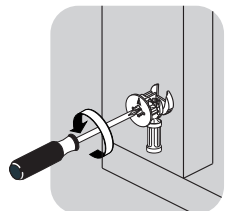
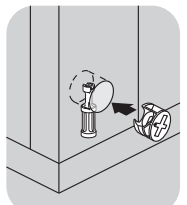
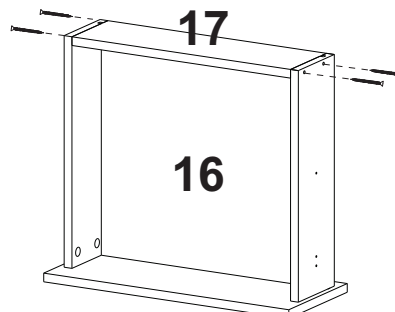

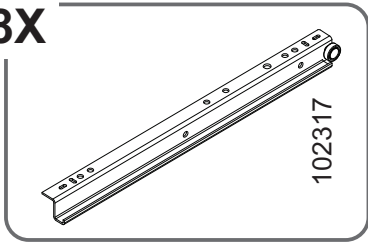
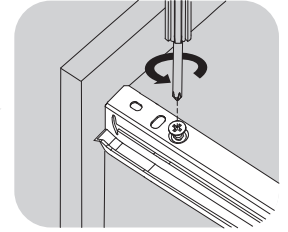
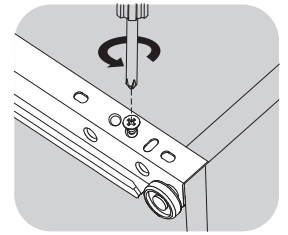
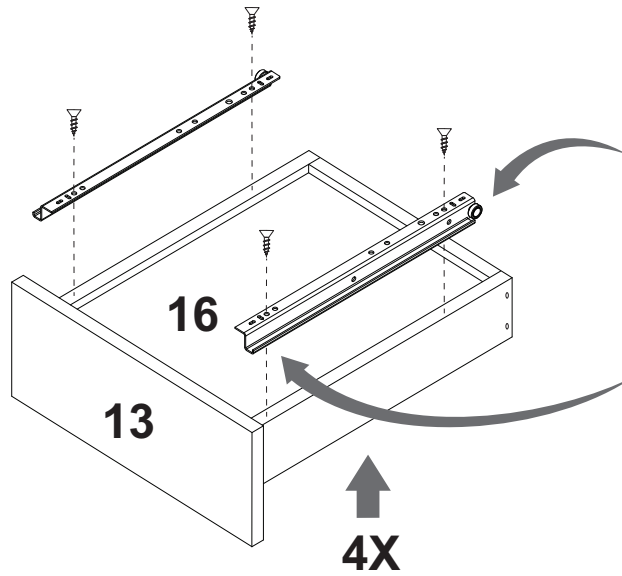
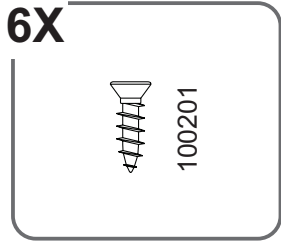
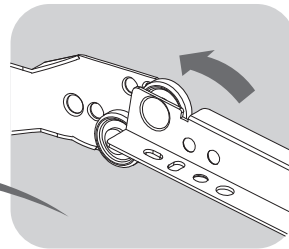
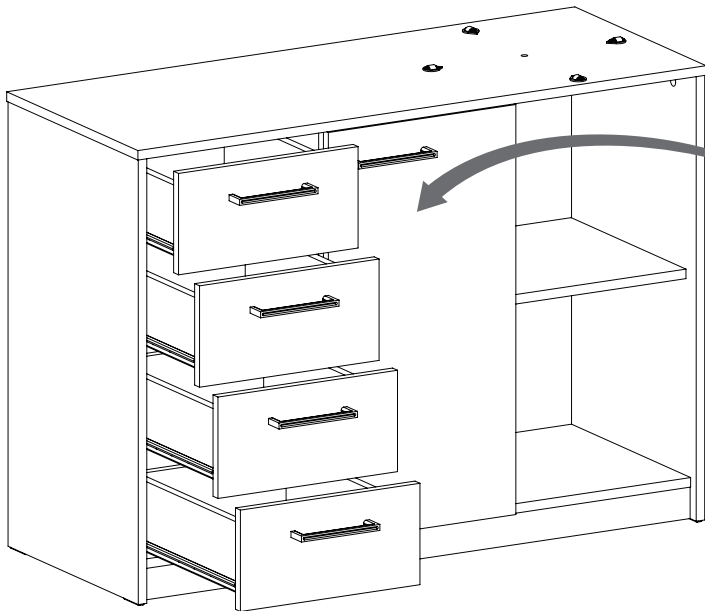
17**8X****16X****18**

ATENÇÃO
ATENCIÓN / ATTENTION

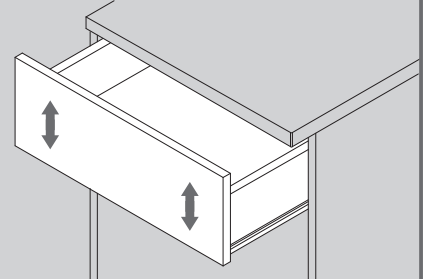

Ajustar a gaveta e colocar os parafusos

Ajustar el cajón y poner los tornillos
Adjust the drawer and put the screws

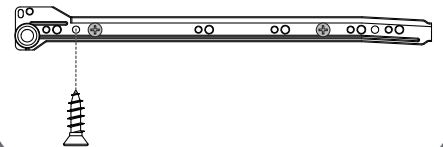
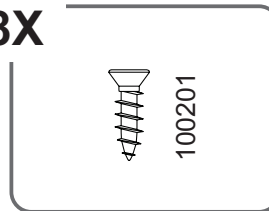
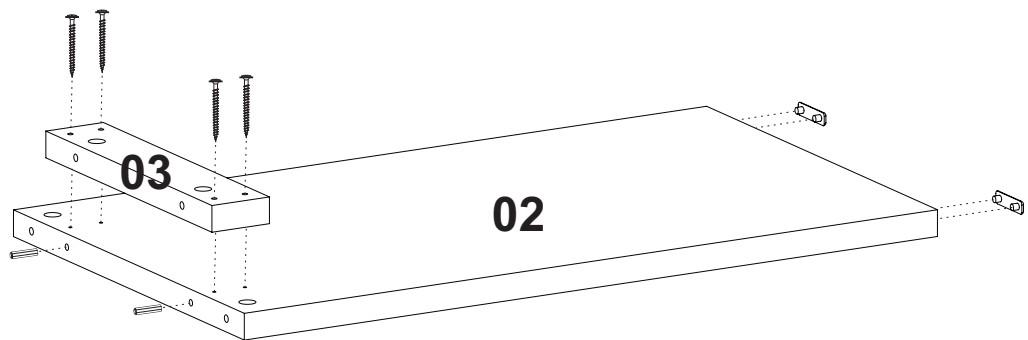
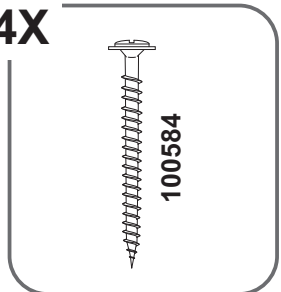
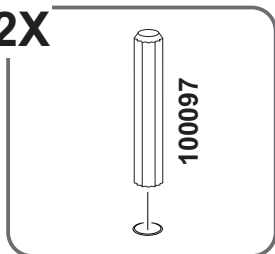
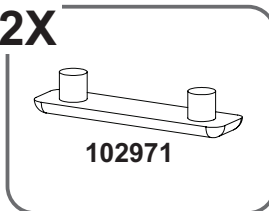
8X**19****4X****2X****2X**

20

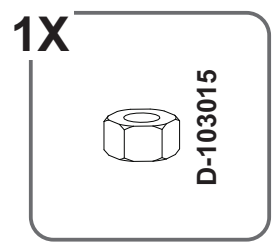
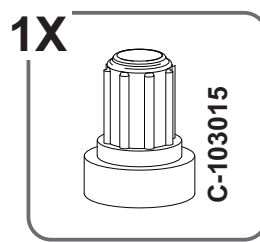
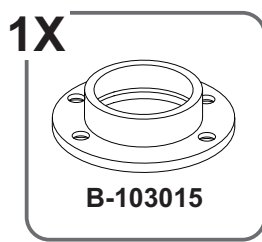
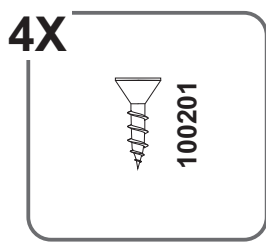
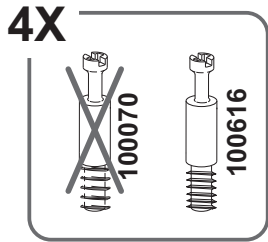
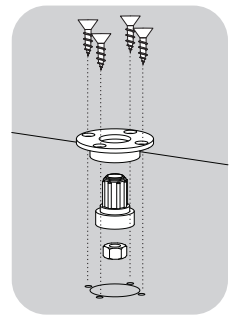
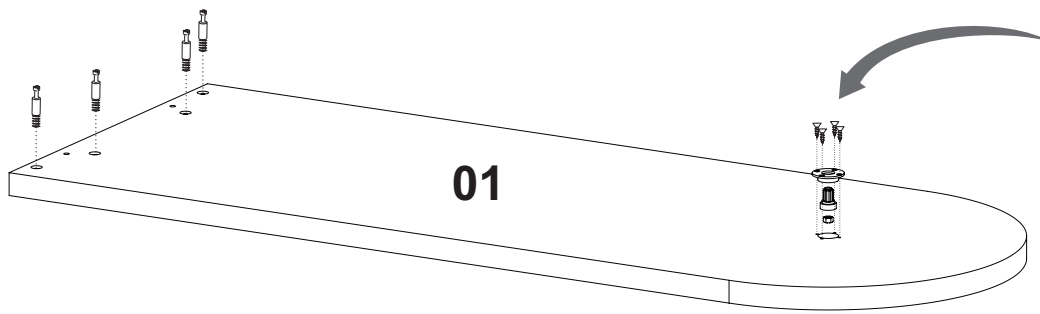

21

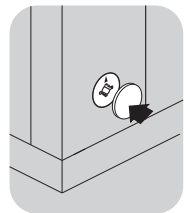
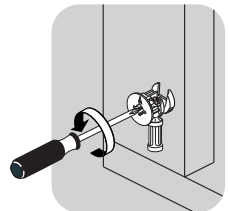
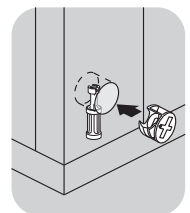
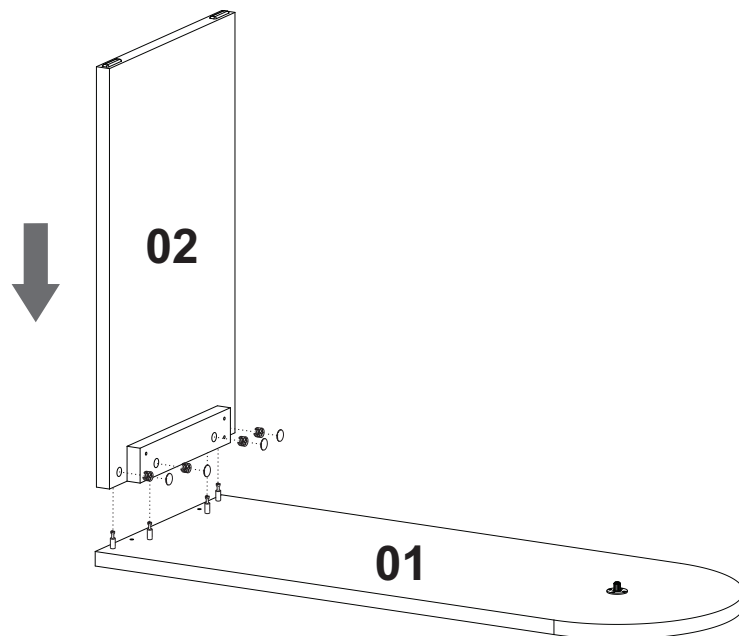
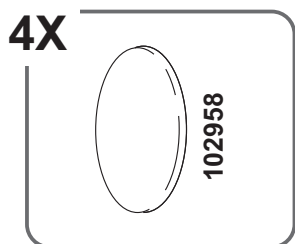

22

