

# AV4004

## Aparador Viena

# Instruções de montagem

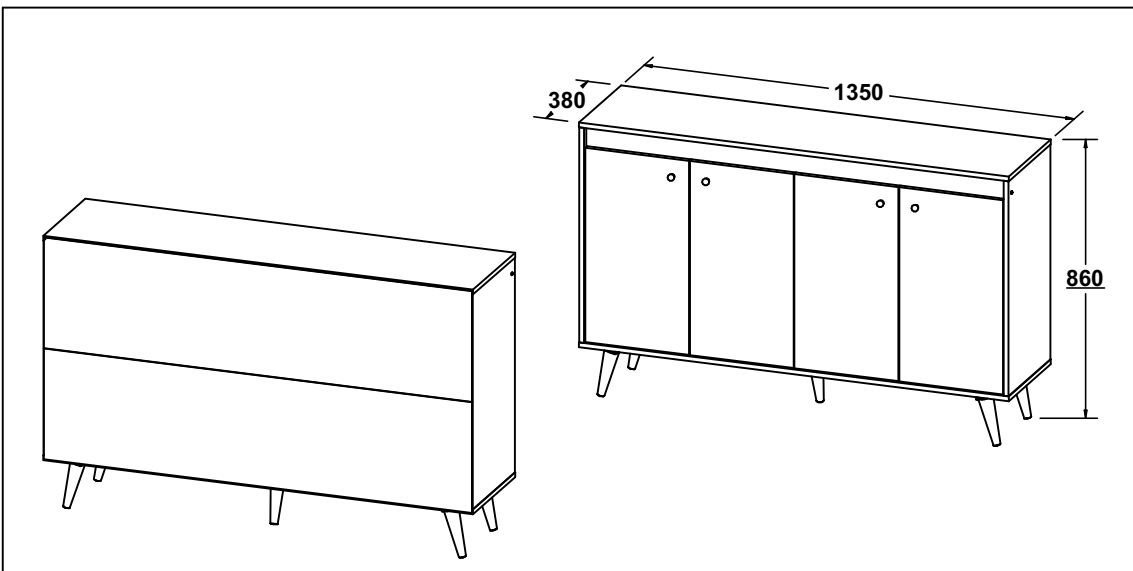





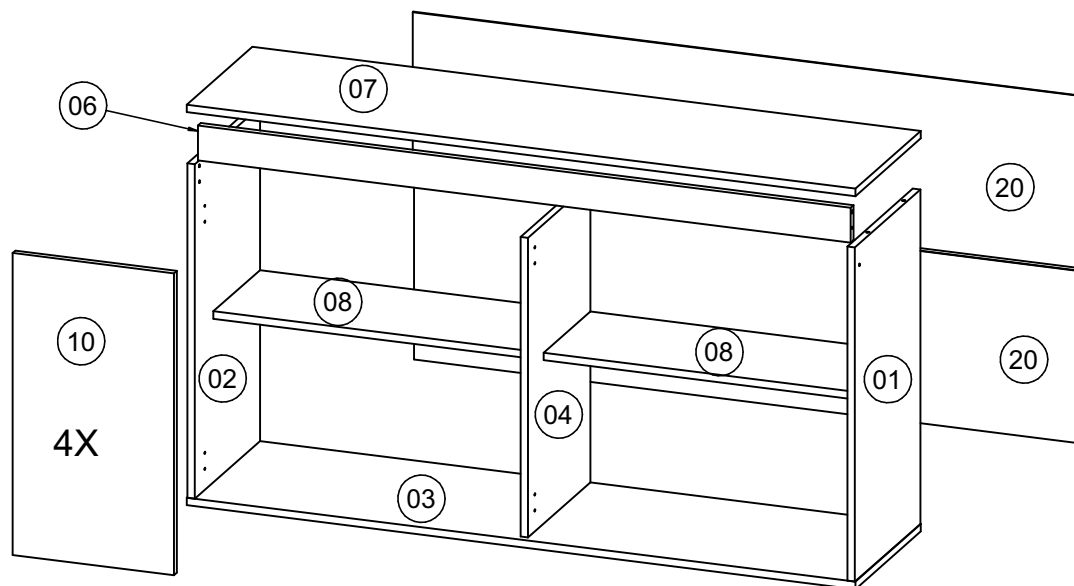





## Assembly Instructions / Instrucciones de Montaje



REV.: 00  
DATA: 05/05/2021

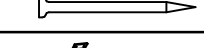
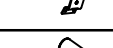
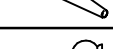
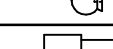

LISTA DE PEÇAS / LISTA DE PIEZAS / PARTS LIST			
COD	DESCRIÇÃO / DESCRIPCIÓN / DESCRIPTION	DIM / DIM / DIM	QTD
01	LATERAL DIREITA/ LATERAL DERECHO/ RIGHT SIDE	670 x 380 x 15	1
02	LATERAL ESQUERDA/ LATERAL IZQUIERDA/ LEFT SIDE	670 x 380 x 15	1
03	BASE/ BASE/ BASE	1350 x 380 x 15	1
04	DIVISÃO/ DIVISIÓN/ DIVISION	600 x 363 x 15	1
06	TRAVESSA/ TRAVESAÑO/ CROSSPIECE	1318 x 70 x 15	1
07	TAMPO/ TAPA/ TOP	1350 x 380 x 15	1
08	PRATELEIRA/ ESTANTE/ SHELF	651 x 280 x 15	2
10	PORTA/ PUERTA/ DOOR	326 x 605 x 15	4
20	COSTA/ FONDO/ BACK	1345 x 345 x 3	2

LISTA DE FERRAGENS / LISTA DE ACCESÓRIOS / HARDWARE LIST		
COD	DESCRIÇÃO / DESCRIPCIÓN / DESCRIPTION	QTD
A	 CAVILHA Ø6X30 CLAVIJA Ø6X30 WOOD DOWEL Ø6X30	12
AA	 PARAFUSO CF 3,5X25 TORNILLO CF 3,5X25 SCREW CF 3,5X25	4
AB	 PARAFUSO CF 4,5X16 TORNILLO CF 4,5X16 SCREW CF 4,5X16	20
B	 PARAFUSO CC 3,5X14 REBAIXE TORNILLO CC 3,5X14 SCREW CC 3,5X14	40
C	 PARAFUSO CC 3,5X40 TORNILLO CC 3,5X40 SCREW CC 3,5X40	6
D	 PARAFUSO CF 3,5x40 TORNILLO CF 3,5x40 SCREW CF 3,5x40	2
DA	 DOBRADIÇA ALTA CALÇO 12 BISAGRA HINGE	4
DB	 DOBRADIÇA ALTA CALÇO 5 BISAGRA HINGE	4
L	 CANTONEIRA ESQUINERO CORNER	4
M	 PREGO 10X10 CLAVO 10X10 NAIL	50
P2	 CHAPINHA PE PLACA DE PIE FOOT PLATE	5
PE	 PE PIE FOOT	5
PX	 PUXADOR TIRADOR HANDLE	4
S	 SUPORTE PRATELEIRA SOPORTE DE ESTANTE SHELF SUPPORT	8
V	 COLA PEGAMENTO GLUE	1
Z	 BATENTE SILICONE SILICONE STOP TAPÓN SILICONA	4

**FERRAMENTAS NECESSÁRIAS:**  
**HERRAMIENTAS NECESÁRIAS:**  
**NECESSARY TOOLS:**



**"IMPORTANTE LER COM ATENÇÃO  
E GUARDAR PARA EVENTUAIS  
CONSULTAS".**

**"IMPORTANTE LEER CON ATENCIÓN Y GUARDAR PARA  
EVENTUALES CONSULTAS".**

**"IMPORTANT TO READ CAREFULLY AND SAVE FOR ANY  
QUERIES".**

